

Occupant protection

Seat belts

The use of front and rear seat belts is mandatory in most countries. Using seat belts saves lives. They should be worn by all occupants whenever the vehicle is in use, for maximum protection.

This vehicle has an individual lap/shoulder inertia reel seat belt for each occupant.

The inertia operating mechanism of the seat belts allows the wearers to move their upper bodies to reach various controls. The seat belts will lock automatically with accelerated body movement or in the event of emergency braking. Both front seat belts are equipped with pretensioners to assist restraint and safety belt force limiters to help minimise the risk of upper body injuries.

Seat belt height adjustment is provided for driver and front seat passenger to ensure that the seat belt webbing can be positioned to pass over the shoulder without pulling against the neck. It can be locked in any of five positions.

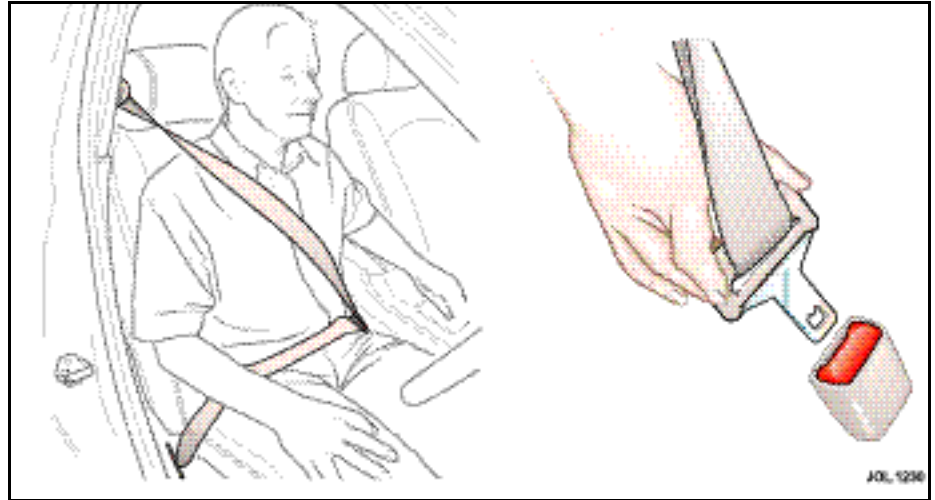

Seat belt fitting



WARNING:
Do not adjust the seat belt while driving.

Draw the tongue of the seat belt over the shoulder, across the chest and push it into the buckle unit slot. A positive 'click' indicates that it is safely locked.

The use of comfort clips or devices that would create slackness in the seat belt system are not recommended.

Always ensure that the webbing is midway between the neck and the edge of the shoulder. Correct tension is controlled by automatic retraction of the reel.

A warning light on the instrument panel comes on for 60 seconds when the driver's seat belt is not fastened. (In some countries, a warning signal sounds for six seconds).

Note: If the vehicle is parked on unlevel ground, the seat belt mechanism may lock. This is not a fault, gently ease the belt from its attachment to unlock it.

3-2 Before driving

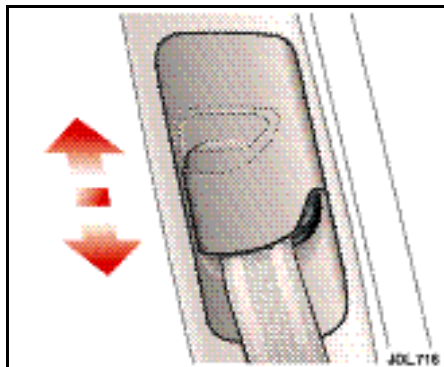

Front belt height adjustment

To operate: Press the locking button and slide the anchorage point to the required position to ensure comfort and safety. Release the button and check that the anchorage point is locked.

Always check the anchorage point after the seat has been adjusted to ensure that the belt is correctly positioned.

Inertia reel mechanism check

Static test: Whilst seated, fasten the seat belt and grip the shoulder belt at approximately shoulder level with the opposite hand. Pull the belt sharply downwards, the belt should lock.

Road test: The following road test must be carried out only under maximum safe road conditions.

With the seat belt correctly fitted to the driver and passenger(s), drive the vehicle at 5 mph (8 km/h) and, ensuring that it is safe to do so, brake sharply.

The seat belt(s) should lock automatically, holding both driver and passenger(s) securely in position.

It is important when braking that the reactions of both driver and passenger(s) are normal, that is, the body must not be thrown forward in anticipation, thus causing a snatching action of the belt which would operate the locking mechanism.

If the belt fails to lock on either test, consult a Jaguar Dealer.



WARNING:

1. **Seat belts are designed to bear upon the bony structure of the body, and must be worn low across the front of the pelvis, or the pelvis, chest and shoulder, as applicable. Wearing the lap section of the belt across the abdominal area must be avoided. Always ensure that the webbing is midway between the neck and the edge of the shoulder.**
2. **Seat belts should be adjusted as firmly as possible, consistent with comfort, to provide the protection for which they have been designed. A slack belt will greatly reduce the protection afforded to the wearer.**

3. Care should be taken to avoid contamination of the webbing with polishes, oils and chemicals, and particularly battery acid. Cleaning may safely be carried out using mild soap and water. If webbing becomes frayed, contaminated or damaged, discard it and fit a new seat belt.
4. It is essential to renew the entire seat belt assembly and the buckle assembly after it has been worn in a severe impact, even if damage to the assembly is not obvious.
5. Belts should not be worn with the webbing twisted.
6. Each seat belt assembly must only be used by one occupant; it is dangerous to put a seat belt around a child being carried on the occupant's lap.
7. No modifications or additions should be made by the user which will either prevent the seat belt adjusting devices from operating, or prevent the seat belt assembly from being adjusted to remove slack.
8. Should the seat belt not retract and remain at its static length, consult your nearest Jaguar Dealer immediately.

3-4 Before driving



Advanced occupant restraint system

In order to provide optimum protection this vehicle is equipped with front and side airbags for driver and front seat passenger. These are supplemental restraint systems which are used in conjunction with the seat belts to help protect the driver and front seat passenger from upper body and head injuries.

Curtain airbags are fitted to the sides of the vehicle for front and rear occupants head protection in the event of a side impact.

To do their life-saving job, airbags open with a great deal of force and this force can pose a potentially dangerous risk in some situations, particularly when a front seat occupant is not properly restrained with the seat belt.

Because airbags must inflate rapidly and with considerable force, there is the risk of death or serious injuries such as fractures, facial and eye injuries or internal injuries, particularly to occupants who are not properly restrained or are otherwise out of position at the time of the airbag deployment.

Airbags do not inflate slowly or gently and the risk of injury from a deploying airbag is greatest close to the trim covering the airbag.

The whole sequence of events from sensing the impact to full inflation of the bag takes place in a fraction of a second.

The driver airbag is located in the centre of the steering wheel and the front seat passenger airbag is located in the fascia panel immediately in front of the passenger seat.

The side airbags are fitted within the driver and front passenger seat outboard seat bolsters, and are identified by a label on the seat.

Curtain airbags are fitted above the doors, under the headlining. These deploy downwards to give protection to the heads of driver, front seat passenger and the outer rear seat occupants.

The airbag warning light in the instrument cluster will be lit for approximately six seconds when the ignition is turned on. If the light remains on or flashes it indicates a fault within the airbag electrical circuits. Report the fault to a Jaguar Dealer immediately.

It is safe to drive the vehicle; however, in an accident the airbags may not operate.



WARNING:

1. No objects whatsoever should be attached to the centre cover of the steering wheel, the passenger fascia panel or the sides of the driver and front passenger seats. Do not put anything on or over the airbag inflation area. Placing objects on or over the airbag inflation area may cause those objects to be propelled by the airbag into your face and torso causing serious injury.
2. Safety experts recommend a minimum distance of at least 10 inches (254mm) between an occupant's chest and a front airbag.
3. Children 12 years old and younger can be killed or seriously injured by the airbag. The rear seat is the safest place for children.
4. Do not try to put an adult seat belt around two children.
5. Several airbag system components get hot after inflation. Do not touch them after they have deployed.
6. Child restraint anchorages are designed to withstand only those loads imposed by correctly fitted child restraints. Under no circumstances are they to be used for adult seat belts or for attaching other items or equipment to the vehicle.
7. DO NOT install a rearward-facing child seat in the front passenger seat position. This is emphasised by the label displayed on the end of the fascia on the front passenger side, as shown on the illustration. If however, you must sit a child in the front passenger seat use only a forward-facing child seat with the passenger seat set fully rearward. Always follow the fitting instructions supplied with the appropriate child restraint system.
8. To ensure that the side airbags are fully effective: DO NOT sit too close to, or lean against, the door trim. The side airbag could injure you as it deploys from the side of the seat. DO NOT lean out of the window aperture. Only use JAGUAR APPROVED accessories (e.g. seat covers). Due to the function of the CURTAIN AIRBAG deployment, CONSULT your Jaguar Dealer prior to installing any ACCESSORIES in the upper environment/pillar trim area (e.g. HANDS-FREE TELEPHONE KITS).
9. If an airbag is inflated, the airbag will not function again and must be renewed immediately. If a new airbag is not fitted, the unrepaired area will increase the risk of injury in a collision.

Airbag warning information is printed on the driver's and passenger's sunvisor. Airbag warning light information is shown on page 4-6.

3-6 Before driving

Wrong
Unbelted and too close

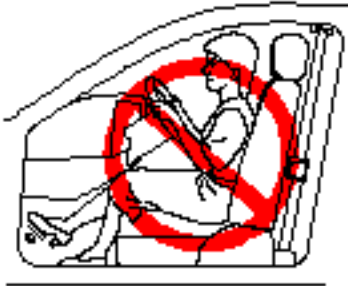

Use Seat Belts

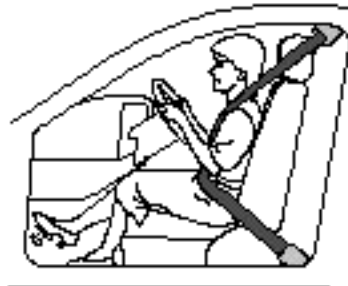

Move Seat Rearwards

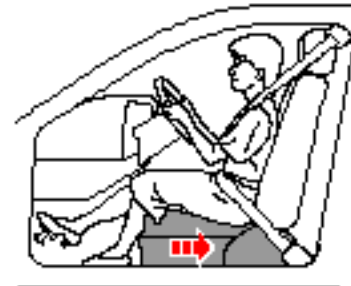

Recline Back of Seat

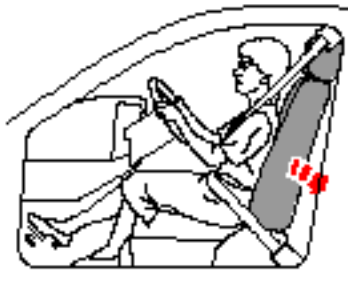

Tilt Wheel Down/Forwards

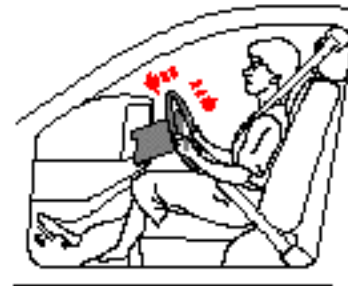

Correct
*Belted and 10inches (254mm)

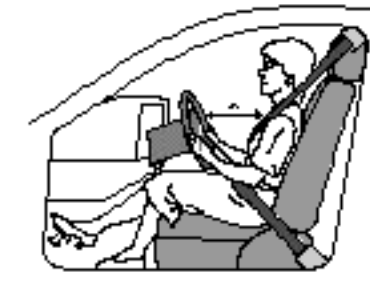



WARNING:

Driver and front seat passenger should always move their seats as far rearwards as is practical.

Ideally, drivers should sit with at least 10 inches (254 mm) between the centre of their breastbone and the cover of the steering wheel airbag.

Since the risk zone at the time of deployment is the first 2 to 3 inches (54 mm–75 mm) from the airbag cover, sitting back 10 inches (254 mm) provides a clear margin of safety. Very few drivers are unable to achieve and maintain that safety gap.

The vast majority of drivers who do not now sit that far back can change their position and achieve that distance.

- Move your seat back as far as you can while still comfortably reaching the pedals.
- Recline the back of your seat one or two notches from the upright position. If reclining the back of your seat makes it hard to see the road, raise yourself by using a firm, non-slippery cushion, or raise your seat, if your seat has that feature.

- Tilt the steering wheel/column downwards so as to point the airbag at your chest instead of your head and neck. Adjust the steering wheel/column fore/aft so that it extends towards the driver as little as possible, ensuring that the airbag has plenty of room to deploy.



WARNING:

Do not attempt to service, repair or modify the airbag system or its fuses. All work on the airbag system, including renewal after deployment and renewal at the end of its service life, must be carried out by an authorised Jaguar Dealer.

In the event of the vehicle being dismantled, airbag module removal and disposal **MUST** be made by a qualified person. Instructions can be obtained from an authorised Jaguar Dealer.

The noise and gas associated with the deployment of the airbags is not injurious to health.

After airbag deployment, it is normal to notice a smoke-like, powdery residue or smell the burnt propellant. This may consist of cornstarch, talcum powder or sodium compounds that result from the combustion process that inflates the airbag.

Small amounts of sodium hydroxide may be present which may irritate the skin and eyes, but none of the residue is toxic.

While the system is designed to help reduce serious injuries, it may also cause minor burns, abrasions, swelling or temporary hearing loss.

3-8 Before driving

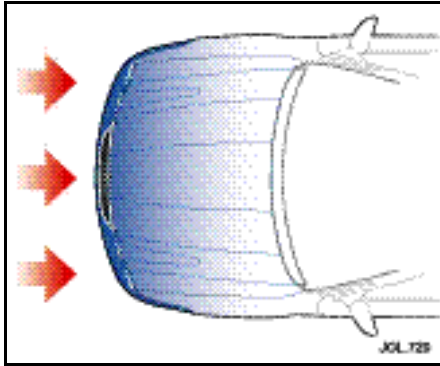

Front airbags

The front airbags use a dual inflation technology and are designed to activate when the vehicle suffers a frontal impact of sufficient force to cause the sensors to close an electrical circuit that initiates airbag inflation. Front airbags use a dual inflation technology which means that, if activated, the bag(s) will deploy at one of two levels of inflation.

Sensors monitor the weight on the front passenger seat. The proximity of the driver to the steering wheel is also sensed. In the event of a collision, the advanced restraint system makes the decision to activate the appropriate airbags, the required inflation level and trigger the seat belt pre-tensioners.

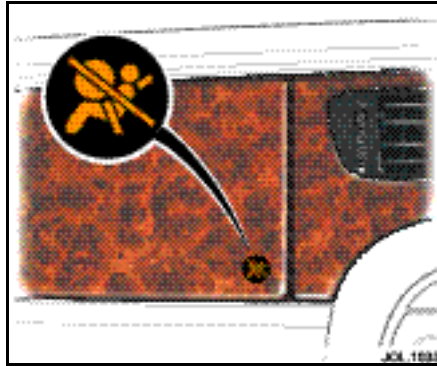

Airbag warning light

The AIRBAG warning light on the passenger fascia is associated with the deployment conditions for front passenger airbags only:

- If the seat is empty, the front and seat mounted side airbags will not be activated and the light will not be lit.
- If the seat is occupied by, for example, a small child, the front and seat mounted airbags will not be activated and the AIRBAG warning light will be illuminated.
- If the seat is occupied by a larger child or adult, the front and seat mounted side airbags will be activated and the warning light will not be illuminated.

With the driver's and front passenger's airbag, the occupant, restrained by the seat belt, moves forward, the head and chest come into contact with the inflated bag. The airbags which then deflate rapidly, in a controlled manner, via vent holes, absorb the remaining energy of the impact.

If the airbags do not inflate in a collision it does not mean that something is wrong with the system.

Rather, it means the forces of the impact were not of the type sufficient to cause activation. Front airbags are designed to inflate in frontal and near frontal collisions, not roll-over, side-impact or rear-impact.

In circumstances where the airbags are not deployed, protection is provided by the seat belts. The severity of the collision is a function of the relative speed and weight of the vehicles or objects colliding. Thus, it is extremely important that occupants be properly restrained as far away from the airbag as possible while maintaining vehicle control.

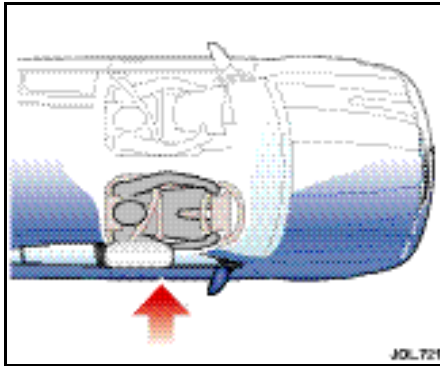

Side protection

The side protection system utilizes four airbags: two seat mounted in the front seats, and two curtain airbags located in the upper environment just above the door openings.

When the seat mounted side airbag inflates upon a vehicle side impact, it breaks through the seat bolster stitching, protecting the side of the rib cage of the driver or front seat passenger.

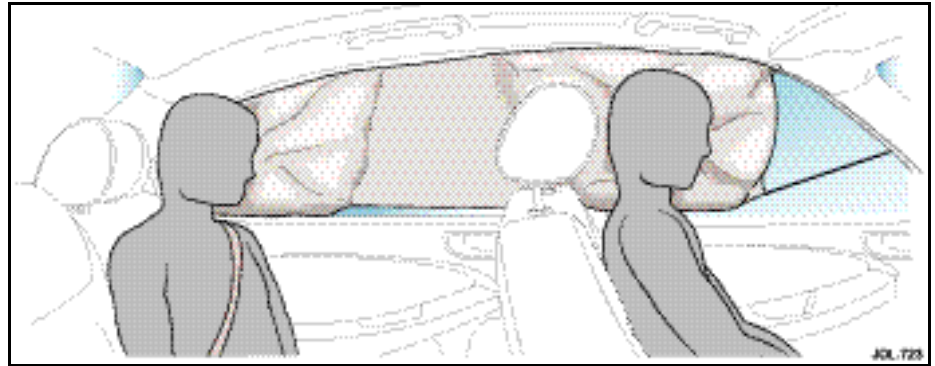

When the curtain airbag inflates upon a vehicle side impact, it breaks through the headlining and deploys downwards, giving head protection to front and rear seat occupants.

The airbags, in combination with the seat belts, can help reduce the risk of severe injuries in the event of a significant side impact collision.

In certain lateral collisions, the airbags on the side affected by the collision will be inflated even if the respective seat is not occupied.

Side and curtain airbags are designed to inflate in a side impact collision, not rollover, rear-impact, frontal or near-frontal collisions, unless the collision causes sufficient lateral deceleration.

3-10 Before driving



Child safety

JAGUAR CARS LTD. STRONGLY RECOMMEND THAT AT ALL TIMES CHILDREN SHOULD BE CARRIED IN THE REAR SEATS.

In many countries legislation governs how and where children should be carried when travelling in a vehicle. It is the responsibility of the driver to comply with all regulations in force in the country where the vehicle is being used.

Holding a baby or child in a person's arms is **not** a substitute for a child restraint system.

In an accident, a baby or child held in a person's arms can be crushed between the vehicle's interior and a restrained person.

The child can also be injured by hitting the interior or by being thrown from the vehicle during a sudden manoeuvre or impact.

Injury can also be caused if the baby or child is allowed to ride on the seat unrestrained. Other occupants should also be properly restrained to help reduce the chance of injuring the child.

Do not allow children to stand in the space between the front seats, or on the rear seats. Children must be restrained by the use of a child safety restraint applicable to their weight and size. The seat must be secured using one of the rear outboard inertia reel seat belts.

Note: A range of safety restraints are available as Jaguar Accessories; consult your Jaguar Dealer for details.

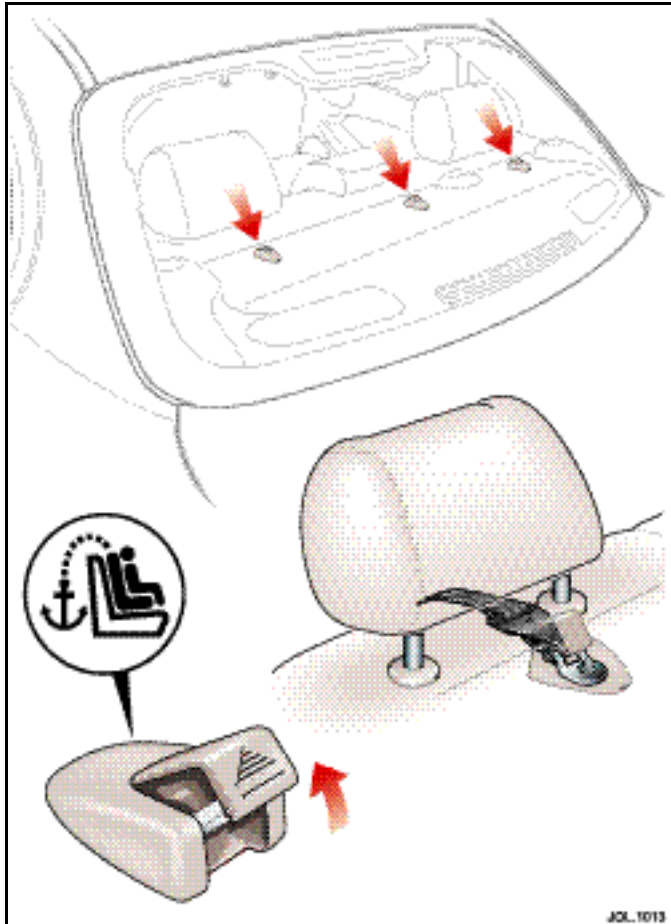

Child restraint tether anchorages and brackets

The tether brackets are positioned on the rear parcel shelf at the centre-line of each rear seating position. The child restraint can be fitted directly to the brackets.

Note: Always ensure that child restraint assemblies are fitted in strict accordance with the child restraint manufacturer's instructions.

Look for the following when selecting a child restraint system:

- It should have a label certifying that it meets the applicable Regulations.
- Carefully read the instructions supplied with the restraint. Be sure you understand them and can install and use the device properly and safely in the vehicle.
- Ensure that the child restraint system is appropriate for the child's weight and development. The label required by the standard or regulations, or instructions for infant restraints, usually provide this information.

Wearing of child restraints

Ensure that there is no slack in the webbing and that the restraint fits the child snugly across the rib cage and hips. These are the parts of the body most able to take the force of impact.

The lap strap should pass across the top of the child's thighs, bearing on the pelvis, not the abdominal area.

Infant safety

Babies and small children who cannot sit up by themselves should be carried in an approved Jaguar baby seat.

3-12 Before driving

Seat adjustment



WARNING:

- 1. Do not make adjustments when the vehicle is moving.**
- 2. Front passengers must not ride with the seat fully reclined.**

Depending upon the vehicle specification, seats have manual and/or electrical adjustment.

Front seat - electrical adjustment

A key does not have to be in the ignition switch for seat adjustment.

The front seats can be adjusted electrically by two switches on the side of the seat cushion.

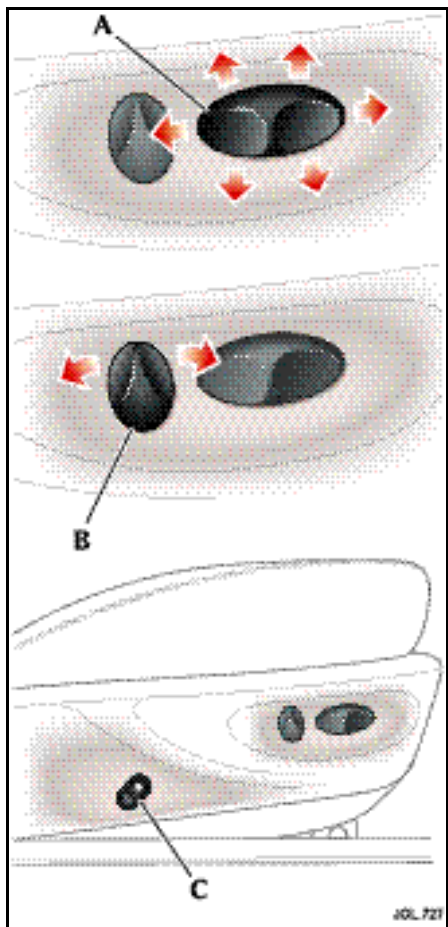

- A.** controls the seat position.
To move the seat forward or rearward – move the switch forwards or rearwards.
Front/rear of cushion raise/lower – move the front or rear of the switch up or down. If both front and rear raise are pulled upwards together the whole seat cushion will rise. If both front and rear lower are pressed down together the whole seat cushion will lower.
- B.** controls the seat back angle.
Move the switch rearwards to recline or forwards to raise the seat back angle.

To adjust the lumbar support, press the switch (C) on the seat. Pressing the top of the switch increases lumbar support, pressing the bottom of the switch decreases lumbar support.

Front seat - manual adjustment

Forward and rearward:

Each front seat can be adjusted forward and rearward by lifting the locking bar(A), situated below the front of the seat cushion and sliding the seat to the required position. After releasing the locking bar, slight additional seat movement may be necessary to engage the locking mechanism.

Height adjustment:

The driver's seat has a switch to adjust the seat for height. The whole seat cushion will raise or lower by moving the switch(B) up or down.

Back adjustment:

To alter the angle of the front seat back, lean forward slightly to relieve body pressure from the seat back and rotate the handwheel (C) in the required direction.

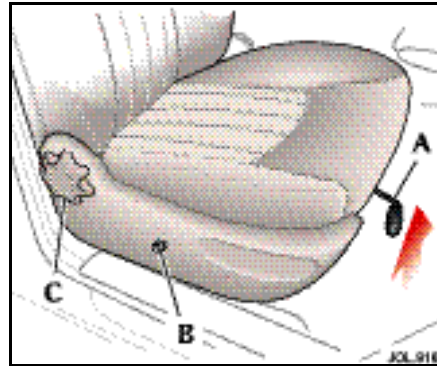

3-14 Before driving

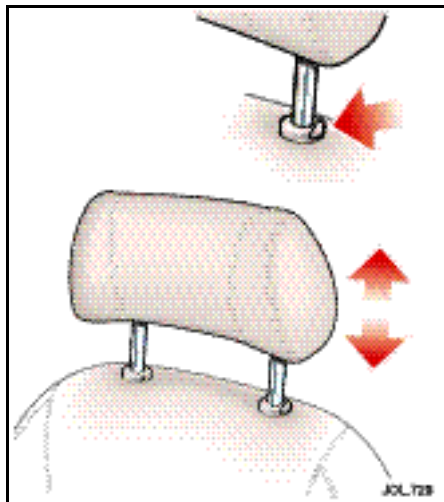

Head restraint adjustment



WARNING:

Adjust the head restraint so that it is just behind your head and never behind your neck.

Each front head restraint can be adjusted to give the correct height for the seat occupant. The head restraints have height and swivel adjustment.

To lower: press the lever in the escutcheon and push the headrest down to the required height.

To raise: pull the headrest upwards.

Rear centre head restraint

The rear centre head restraint has two height positions only. It can be stowed within the seat back when not in use and should be extended when an occupant is in the centre seat.

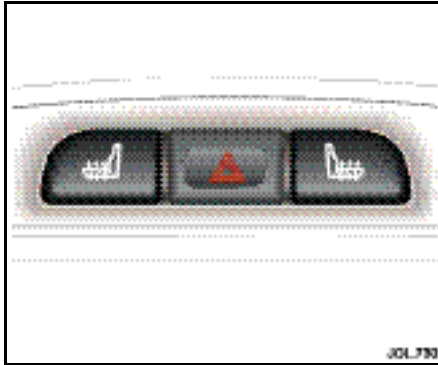

Front seat heaters

Each front seat back and cushion has a heater controlled by a switch on the centre console.

With the ignition switch in position 'II', press the switch to turn the heaters on.

The first press will heat the seat to a high temperature setting, a second press will heat the seat to a lower setting.

A third press will turn the seat heater off.

A light within the switch will show when the heater is ON, red for the high heat setting and yellow for the lower setting.

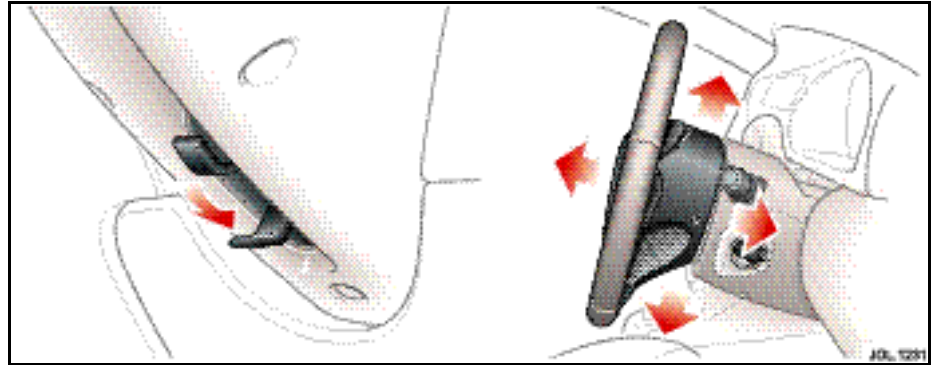

Steering column adjustment



WARNING:

Do not adjust the steering column whilst driving.

The steering column can be adjusted for reach and height.

Holding the steering wheel, push the release lever fully downwards.

Move the steering wheel up or down and in or out as required, for a comfortable, safe driving position.

After adjustment, fully raise the lever to lock the steering wheel in position.

The heater will automatically switch OFF

- after it has been on for 10 minutes
- if the ignition is turned OFF
- if a fault is detected.

The heater will maintain a pre-set temperature while it is switched on. Storage of the vehicle in a heated garage, body heat or warm ambient temperatures may prevent operation of the seat heater.

3-16 Before driving

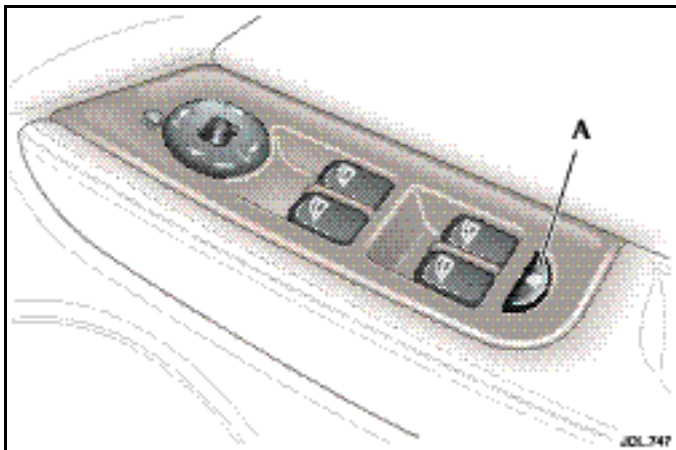

Door window operation

Front windows on all models are electrically operated. Depending on the model, rear windows can be either manually or electrically operated.

Electric window operation

Switches on the driver's door switch pack control the driver and passenger door windows.

The passengers are provided with a switch to control their door window only.

These switches will only operate the window when the ignition switch is in position 'II'.

If electrically operated rear windows are fitted, button (A) immobilises the rear window switches preventing passengers from operating their windows. The button integral red light will be lit when the rear windows cannot be operated by the rear seat passengers.



WARNING:

- 1. When raising windows ensure all occupants are clear.**
- 2. When leaving the vehicle take the ignition keys to prevent misuse of the window switches by remaining occupants, especially children.**

Operation

To lower a window, press down the switch to its first position and hold until the desired position is reached, then release.

To close a window, pull the switch upwards to its first position and hold until the desired position is reached, then release.

If the switches are held for longer than 6 seconds, for example, when attempting to overcome frozen or jammed windows, the window drive will be switched off for a few seconds to protect the window drive motors.

One-touch operation

Each window has a 'one-touch' facility enabling the occupant to fully open or close the window in one quick movement. Pulling, or pressing, the switch to its second position and quickly releasing will close or open the window in one movement. Window travel can be stopped at any time by pressing the switch again.

Window anti-trap feature

Each electrically operated window has an anti-trap feature. If the upward movement of the window detects an obstacle the anti-trap feature will immediately stop the window closing, then move it downwards for a short distance.



WARNING:

If the battery is disconnected or discharged the window anti-trap feature is lost. When the battery is reconnected or recharged the window anti-trap feature must be reset.

To reset the electrically operated windows anti-trap feature:

- Fully close the window, hold the switch in the close position for two seconds and then release the switch. Wait for two seconds, do not open the window.
- Again, select the same window to close, holding the switch for a further two seconds.
- Check to confirm the operation by opening the window and then use one touch operation to close the window.
- Repeat for the remaining electrically operated windows.

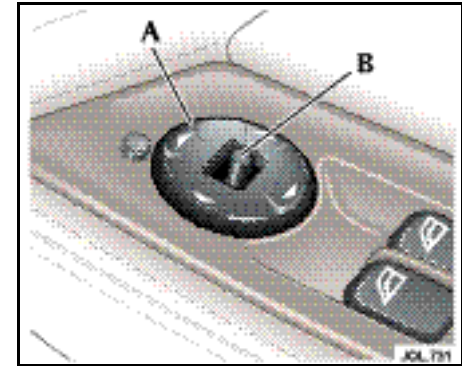

Mirrors

Door rear view mirrors

Both door mirrors are adjusted from the driver's door switchpack. The four-way adjustment button (A) moves the mirrors to the required position. The selector switch (B) selects the mirror to be moved, left for the left-hand side mirror and right for the right-hand side mirror. When the selector switch is in the centre position, adjustment to either mirror is inhibited.

3-18 Before driving

Each mirror housing, except the power fold back door mirror, is designed to pivot against the vehicle upon impact. To return the mirror to its normal position, reposition the housing until it locks into place.

Mirror heating

The door mirrors have heating elements which work when the rear screen heater is switched ON. The mirror heater will clear all ice from the mirror surface.

Caution: Do not use a scraper to remove ice from the mirrors as this will damage the surface.

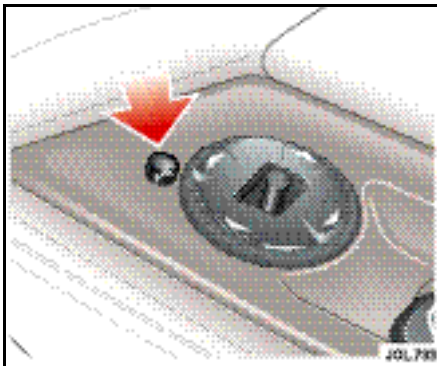

Door mirrors – power fold back

To assist parking by reducing the overall vehicle width, the door mirrors can be folded inwards.

The switch is located in the driver's door window switchpack and will operate the mirrors when the ignition switch is in any position except OFF.

To fold the mirrors inwards press the button. A second press of the button returns the mirrors to their normal driving position.

Note:

1. Do not attempt to reposition power fold back mirrors manually. Always use the button.
2. Should a door mirror be knocked out of position the mirror head will be loose. To re-engage the mechanism, power the mirror to the foldback position, then outwards to the drive position.

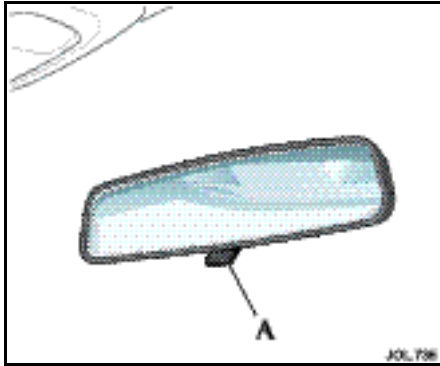

Interior rear view mirror

Interior mirrors are either manual dip or electrochromic.

Interior rear view mirror – manual dip

The interior rear view mirror can be dipped to prevent glare from a following vehicle's headlamps by pulling lever (A). Pushing the lever returns the mirror to its daytime setting.

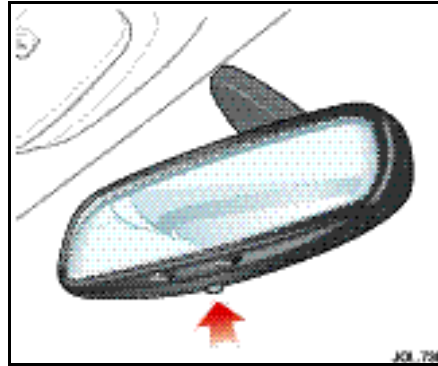

Interior rear view mirror – electrochromic

Push the switch in and the electrochromic rear view mirror darkens automatically to prevent glare from a following vehicle's headlamps. The mirror clears when light levels return to normal. The mirror also clears when reverse gear is selected.

Push the switch again and the glare-reducing effect of the mirror is switched off so that a clear reflection is given.

Note:

1. Should a mirror assembly become detached from the windscreen, it must be refitted by a Jaguar Dealer.
2. Ensure that the windscreen in front of the mirror is kept clean. Where fitted, the moisture sensor for wiper operation is located to the front of the mirror casing. Any dirt may affect the operation of this sensor.

3-20 Before driving

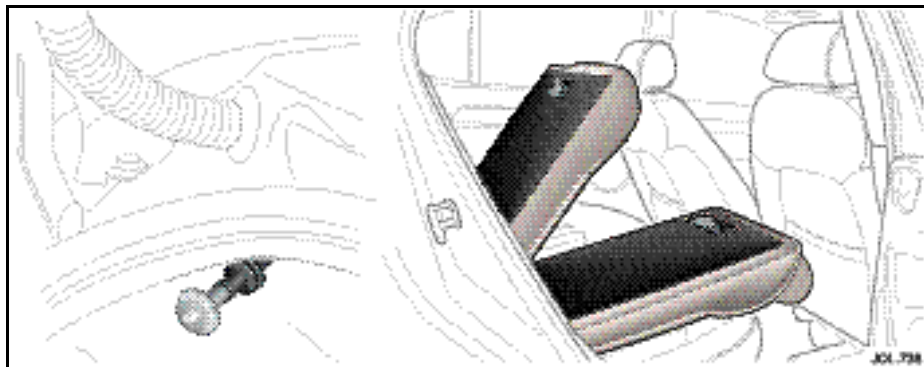

When returning the seat back to the upright position ensure that the seat belts are routed correctly and are not trapped by the seat back. Press the seat back firmly and check that it is locked securely into place.

Luggage compartment



WARNING:

- 1. Locate heavy loads in the luggage compartment towards the front of the vehicle and secure them to stop them sliding. Loose items can be a hazard.**
- 2. Do not drive with the luggage compartment lid open as exhaust fumes can be drawn into the passenger compartment.**

Rear seatback fold down

To provide a longer luggage compartment area, the backs of the rear seat can be folded down in two parts to give a 70/30 width split.

Release handles for each seat back are in the luggage compartment under the parcel shelf.

Pull the selected side handle to release the seat back and then fold it onto the seat cushion.

Ensure when folding the seat back down that the armrest is stowed and that there is sufficient clearance between the seat back, including the headrest, and the back of the front seat.

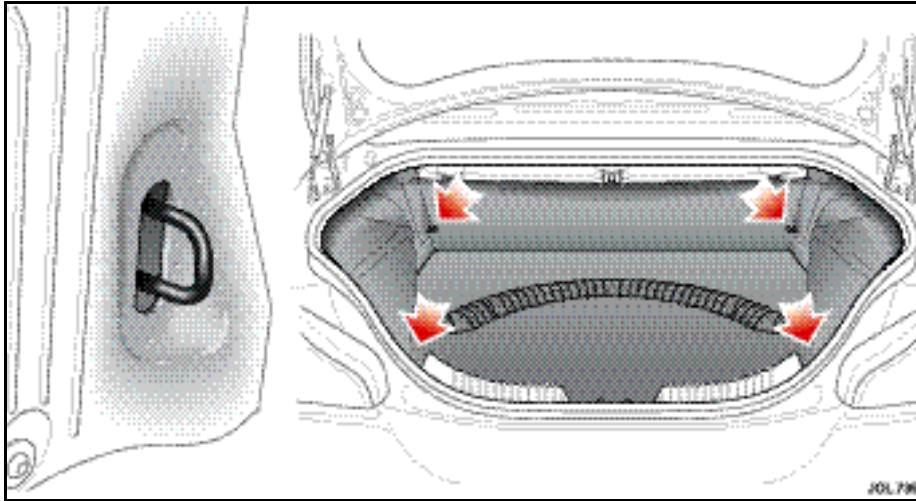

Luggage tie-down loops

Four metal loops are positioned in the luggage compartment for attaching straps to secure loads and prevent them from sliding over the luggage floor.

These loops are not to be used for securing passengers or animals nor as anchorages for child restraints.

A range of Jaguar storage accessories, including a luggage retaining net, are available from your Dealer.

It is advisable to distribute luggage weight evenly over the entire luggage floor area, particularly to prevent permanent damage to the seat trim when a seat has been folded down.

3-22 Before driving

Ski hatch

A two-door hatch is fitted to the rear seat which, when open, gives a space for skis or similar objects to be stowed in the vehicle. Both doors have a single catch.

The inner door is accessible after folding down the armrest. To open the door, press the catch (A) downwards and gently lower the door on to the armrest.

A bag for retaining the skis can now be pulled from the receptacle into the passenger compartment, and the strap (C) loosened ready to accept the skis.

The other door is accessible from inside the luggage compartment and is opened by pushing the catch (B) and lowering the door.

Push the skis into the bag from the luggage compartment and then secure the skis using the strap provided on the bag. Clip the strap connector (D) to the centre rear seat belt buckle.

