

Occupant Protection

SEAT BELTS



WARNING:

Seat belts are designed to bear upon the bony structure of the body, and should be worn low across the front of the pelvis or the pelvis, chest and shoulders, as applicable; wearing the lap section of the belt across the abdominal area must be avoided.



WARNING:

Seat belts should be adjusted as firmly as possible, consistent with comfort, to provide the protection for which they have been designed. A slack belt will greatly reduce the protection afforded to the wearer.



WARNING:

Care should be taken to avoid contamination of the webbing with polishes, oils and chemicals, and particularly battery acid. Cleaning may safely be carried out using mild soap and water.



WARNING:

The belt should be replaced if webbing becomes frayed, contaminated or damaged.



WARNING:

It is essential to replace the entire assembly after it has been worn in a severe impact even if damage to the assembly is not obvious.



WARNING:

Belts should not be worn with the straps twisted.



WARNING:

Do not carry hard, fragile, or sharp items between your person and the seat belt. In an impact the pressure from the seat belt on such items can cause them to break, which in turn may cause death or serious injuries.



WARNING:

Each belt assembly must only be used by one occupant; it is dangerous to put a belt around a child being carried on the occupant's lap.



WARNING:

The occupants of the front seats should not travel with the seat back at more than 30 degrees from upright. Doing so will reduce the protection afforded by the seat belt.



WARNING:

Seat belts should be worn at all times, by the driver and passengers in all seating positions. The airbag SRS cannot provide protection in some types of impact. Under these circumstances the only protection will be provided by a correctly worn seat belt.

Occupant Protection



WARNING:

Seat belts should be worn by all vehicle occupants, for every journey no matter how short. Failure to do so will greatly increase the risk of death or serious injury in the event of an accident.



WARNING:

No modifications or additions should be made by the user which will either prevent the seat belt adjusting devices from operating to remove slack, or prevent the seat belt assembly from being adjusted to remove slack.

A slack seat belt offers a greatly reduced level of occupant protection in an impact.



WARNING:

If any damage, wear, cuts, defects, or impaired operation are noted with the seat belts, the vehicle should be taken to a Jaguar Dealer/Authorised Repairer for immediate attention. Do not use the vehicle if the seat belts cannot be operated correctly.



WARNING:

When using seat belts to restrain items other than occupants, take care to ensure that the belts are not damaged, or exposed to sharp edges.

Caring for seat belts

Note: If the vehicle is parked on an incline, the seat belt mechanism may lock. This is not a fault, and the belt should be gently eased out from the upper anchorage.

The seat belts should be inspected regularly to check for fraying, cuts, or wear to the webbing, and the condition and security of the mechanism, buckles, adjusters, and mounting points.

Testing inertia reel belts

- With the seat belt fastened, give the webbing near the buckle a quick upward pull. The buckle must remain securely locked.
- With the seat belt unfastened, unreel the seat belt to the limit of its travel. Check that it unreels smoothly with no snatches or snags. Allow the belt to fully retract, again checking for smooth operation.
- Partially unreel the seat belt, then hold the tongue plate and give a quick forward pull. The mechanism must lock and prevent any further unreeling.

If any of the seat belts fail to meet those criteria, immediately contact your Jaguar Dealer/Authorised Repairer.

Occupant Protection

SEAT BELT FITTING



WARNING:

Do not adjust the seat belt whilst driving.

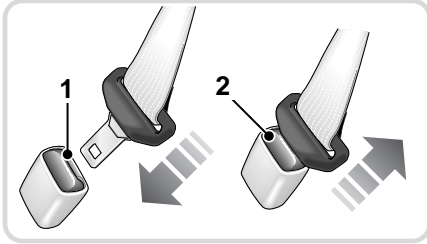

JAG0678

Draw the tongue of the seat belt over the shoulder, across the chest and push it into the buckle unit slot **1**. A positive click indicates that it is safely locked.

Always ensure that the webbing is midway between the neck and the edge of the shoulder. Correct tension is controlled by automatic retraction of the reel.



A warning indicator on the instrument panel comes on when the driver's seat belt is not fastened.

Note: In some countries a warning signal may also sound for six seconds.

Belt buckle release

To release the belt buckle, press the release button **2** in the buckle unit and allow the seat belt to fully retract.

Note: When releasing the seat belt it is advisable to hold the belt before pressing the release button. This will prevent the belt from retracting too quickly.

Occupant Protection

Front belt height adjustment



WARNING:

Correct seat belt adjustment is essential for safety and comfort. Ensure that the height is correctly adjusted and the mechanism is locked in place before driving the vehicle. Do not attempt to adjust the seat belt height once the vehicle is in motion. Doing so may cause you to lose control of the vehicle, or incorrectly adjust the seat belt.

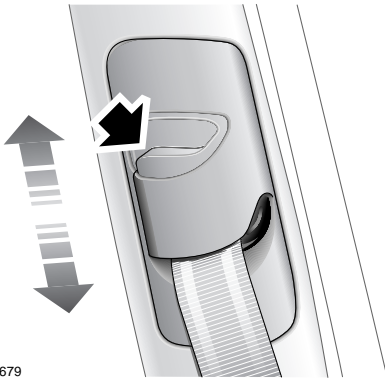

JAG0679

Press the locking button and slide the anchorage point to the required position. Release the button and check that the anchorage point is locked.

Always check the anchorage point after the seat has been adjusted to ensure that the belt is correctly positioned.

USING SEAT BELTS DURING PREGNANCY



WARNING:

Position the seat belt correctly for the safety of the mother and unborn child. Never wear just the lap strap, and never sit on the lap strap whilst using just the shoulder strap. Both of these actions are extremely dangerous, and may increase your risk of serious injury in the event of an accident or during emergency braking.



WARNING:

Never place anything between you and the seat belt in an attempt to cushion the impact in the event of an accident. It can be dangerous, and will reduce the effectiveness of the seat belt in preventing injury.

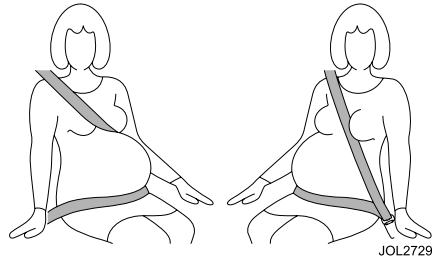

Position the lap strap comfortably across the hips beneath the abdomen. Place the diagonal part of the seat belt between the breasts and to the side of the abdomen. Ensure that the seat belt is not slack or twisted.

Occupant Protection

AIRBAGS

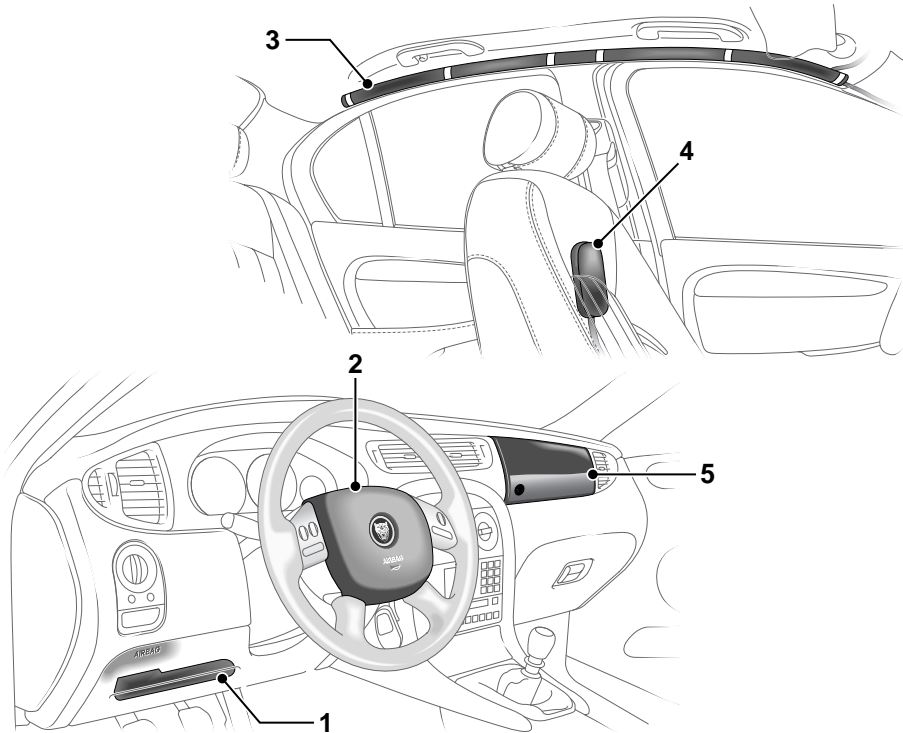

JAG0808

1. Driver's knee airbag (where fitted).
2. Driver's airbag.
3. Curtain airbag (left-hand side and right-hand side).
4. Seat mounted side airbag (left-hand and right-hand front seats).
5. Front passenger airbag.

Occupant Protection



WARNING:

No objects whatsoever should be attached to the centre cover of the steering wheel, the passenger fascia panel, the sides of the front seats or the interior trim immediately above the door openings. Do not put anything on or over the airbag inflation area. Placing objects on or over the airbag inflation area may cause those objects to be propelled by the airbag into your face and torso causing serious injury.



WARNING:

Several airbag system components get hot after inflation. Do not touch them after they have deployed.



WARNING:

Airbags inflate at high speeds, and can cause injuries. To minimise the risk of injury, ensure that all vehicle occupants wear correctly positioned seat belts, sit correctly in the seats, and position the seats as far back as practical.



WARNING:

Airbag inflation takes place instantaneously, and cannot protect against the effects of secondary impacts. Under these circumstances the only protection will be provided by a correctly worn seat belt.



WARNING:

Driver and front seat passenger should always move their seats as far rearwards as is practical.

Front airbags

With a front impact of sufficient force, the restraints system will trigger the front airbag(s) and seat belt pretensioners.

Both front airbags use dual inflation technology which means that if activated, the bag(s) will deploy at either a normal or reduced level of inflation, depending on crash severity. The lower level is also selected if the driver is close to the steering wheel.

In certain conditions, e.g. where no passenger is present, the appropriate airbags will be deactivated: in a collision these airbags would not be deployed.

Note: Front airbags are designed to inflate in frontal and near-frontal collisions, not low speed impacts, roll-over, side-impact or rear-impact.

Occupant Protection

Side protection

The side protection system utilizes four airbags: one mounted in each of the front seats, and two curtain airbags located in the upper environment just above the door opening.

When the seat mounted side airbag inflates upon a vehicle side impact, it breaks through the seat bolster stitching, protecting the side of the rib cage of the driver or front seat passenger.

When the curtain airbag inflates upon a vehicle side impact, it breaks through the headlining and deploys downwards, giving head protection to front and rear seat occupants.

The airbags, in combination with the seat belts, can help reduce the risk of severe injuries in the event of a significant side impact collision.



WARNING:

For the airbags to operate correctly the roof lining and door post trims must be in good condition, correctly fitted, and free from obstruction. Any damage, wear, or incorrect fitment should be referred to your Jaguar Dealer/Authorised Repairer as soon as possible for examination and repair.



WARNING:

Do not allow passengers to obstruct the operation of the airbags by placing any part of their person, or any objects, in contact with, or close to, an airbag module. Airbags deploy at very high speeds, and can cause serious injury or death if objects or occupants are within the area of deployment.

Driver's knee airbag

The driver's knee airbag provides an additional method of restraining the driver in the event of a frontal or near-frontal collision.

The driver's knee airbag is fitted to all four-wheel drive models. It is located in the panel below the steering column and will normally deploy at the same time as the driver's airbag.



WARNING:

- **The driver's knee airbag will not deploy if the driver's seat is near to its full forward position. Do not sit too close to the steering wheel.**
- **Do not attach any objects whatsoever to the driver's knee airbag panel; it could cause injury in the event of a collision. Consult your Jaguar Dealer/Authorised Repairer before installing any accessories in the driver's facia area (e.g. hands-free telephone kits).**

Occupant Protection

Airbag deployment effects



WARNING:

When an airbag inflates a fine powder is released. This is normal and not an indication of a malfunction. However, the powder may cause irritation to the skin, and should be thoroughly flushed from eyes, and any cuts or abrasions.



WARNING:

In order to react with sufficient speed, airbags are deployed by an explosive charge. Consequently airbag deployment is accompanied by a very loud noise which may cause discomfort and temporary loss of hearing.

OCCUPANT SENSING



JAG0809

The airbag status indicator (occupant sensing) is located on the passenger facia.

The sensor measures the weight on the cushion and changes the passenger airbag deployment status.

The occupant sensor operates as follows:

Seat occupancy status	Passenger airbag status	Status indicator on
Completely empty	Deactivated	No*
Low weight occupant/object	Deactivated	Yes
Heavy occupant/object	Activated	No
Child restraint fitted	Deactivated	Yes**

*It is possible that the airbag status indicator will illuminate intermittently when the seat is empty. This is part of the system's adaptive behaviour, and does not affect the status of the passenger airbag. However, if the status indicator is permanently illuminated when the seat is definitely empty, then contact your nearest Jaguar Dealer/Authorised Repairer immediately.

**In some cases a small child placed in a child seat will not illuminate the status indicator. If this occurs, the passenger airbag status will be as described for an empty seat, i.e. passenger seat airbag deactivated but the status indicator will not illuminate.

Occupant Protection

AIRBAG WARNING LAMP



The airbag warning indicator in the driver's instrument pack will be lit for approximately six seconds when the starter switch is turned on.

If the indicator remains illuminated or flashes, it indicates a fault within the airbag electrical circuits. Report the fault to a Jaguar Dealer immediately.

It is safe to drive the vehicle; however, in an accident the airbags may not operate.

It is safe to drive the vehicle, however, in an accident the airbags may not operate.

The following components are monitored by the airbag system.

- Driver's dual-stage airbag (steering wheel)
- Driver's side thorax airbag
- Driver's pretensioner
- Driver's side crash sensor - 2 off
- Passenger's dual-stage airbag
- Passenger's side thorax airbag
- Passenger's pretensioner
- Passenger's side crash sensor - 2 off
- Passenger's seat occupant sensor
- Restraint control module.



WARNING:

If the warning indicator signals that a fault is present in the system, do not use a child restraint on the front passenger seat. Doing so will increase the risk of death or serious injury to the child.

AIRBAG LABELS

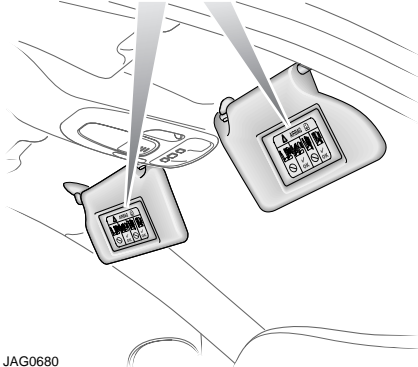

JAG0680

Airbag warning information is printed on the driver's and passenger's sun visor. See 'AIRBAG WARNING LAMP', page 64.

Occupant Protection

AIRBAG SERVICE INFORMATION



WARNING:

For your safety a Jaguar Dealer/Authorised Repairer must carry out any of the following tasks.

Removal, replacement, repair, or modification, of any wiring or component in the vicinity of the SRS components, including the steering wheel, steering column, door trim, roof lining, instrument pack and instrument panel.

Installation of electronic equipment such as a mobile phone, two-way radio or in-car entertainment system.

Modification to the front or side of the vehicle, including the bumper and chassis.

Attachment of accessories to the front or side of the vehicle.

In addition, always contact your Jaguar Dealer/Authorised Repairer if:

- An airbag inflates.
- A seat belt pre-tensioner activates.
- The front or side of the vehicle is damaged, even if the airbag has not inflated.
- Any part of the airbag module cover shows signs of cracking or damage.
- Any trim containing an airbag - front seat back, headlining or pillar trims - becomes damaged.

Airbag disposal



WARNING:

Do not attempt to service, repair or modify the airbag system or its electrical fuses. All work on the airbag system, including renewal after deployment must be carried out by an authorised Jaguar Dealer/Authorised Repairer.

In the event of the vehicle being dismantled, airbag module removal and disposal must be made by a qualified person. Instructions can be obtained from a Jaguar Dealer/Authorised Repairer.

Child Safety

CHILD AND INFANT SAFETY

It is very important for all infants and children under 12 years of age to be restrained in a suitable child safety seat appropriate to their age and size.

Note: *It is important to read and understand all the information contained in this handbook relating to child safety before carrying a child in your vehicle. If you are unsure about any aspect of this information, contact your Jaguar Dealer/Authorised Repairer.*

Infant Safety

Babies and small children who cannot sit up by themselves should be carried in an approved baby seat.



WARNING:

Children must be restrained by a child safety restraint that is suitable for their weight and size. We recommend that a Jaguar approved restraint is used.



WARNING:

Do not allow a baby or infant to be held or carried on the lap. The force of a crash can increase effective body weight by as much as thirty times, making it impossible to hold onto the child. Children typically require the use of a booster seat appropriate to their age and size, thereby enabling the seat belts to be properly fitted, reducing the risk of injury in a crash. Children could be endangered in a crash if their child restraints are not properly secured in the vehicle.



WARNING:

Crash statistics show that children are safest when properly restrained on the rear seat.



WARNING:

Do not use a child seat that hooks over the seat back. This type of seat cannot be satisfactorily secured and is unlikely to be safe for your child.



WARNING:

Do not use a forward facing child seat until the child using it is above the minimum weight of 9 kg (20 lb.) and able to sit up unaided. Up to the age of two, a child's spine and neck are not sufficiently developed to avoid injury in a frontal impact.



WARNING:

Choose a child seat that sits securely on the seat cushion and against the seat back.



WARNING:

Always use the top tether to secure a forward facing child seat, where possible.

Child Safety



WARNING:

**Original text according to ECE R94.01.
Extreme hazard! Do not use a rearward facing child restraint on a seat protected by an airbag in front of it!**

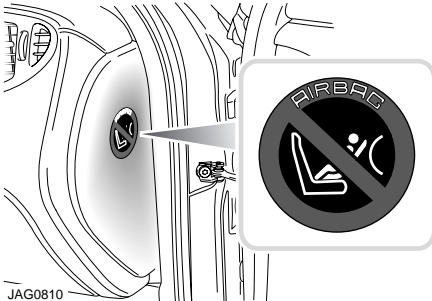

JAG0810

This symbol affixed to the end of the passenger side of the facia, warns against the use of a rear-facing child seat when the front seat passenger airbag is operational.



WARNING:

Do not use a child restraint on a seat with an operational airbag in front of it. There is a risk of death or serious injury when the airbag deploys.

Jaguar Cars Limited strongly recommends that at all times children should be carried in the rear seats.

If, however, you have no alternative but to place a child in the front passenger seat, use only a forward-facing child seat with the passenger seat set fully rearward and in its lowest position.

Make sure you read the information in this section which contains:

- General advice about the use of child restraints.
- Specific information about installing a non-ISOFIX child restraint.
- Specific information about fitting the ISOFIX child restraint system.

Child Safety

Child seat positioning

Suitability of each passenger seat position for the carriage of children up to 12 years of age, or 1.5 m (5 feet) tall, and the installation of child restraint systems:

Note: The information contained in the following table may not be applicable to all countries. If you are in any doubt regarding the type and fitment of child seats seek advice from your Jaguar Dealer/Authorised Repairer.

Mass Group (with approximate age) as indicated on child restraint	Vehicle Seating Position		
	Front Passenger*	Rear Outboard	Rear Centre
0 = Up to 10 kg (22 lb) (birth to 10 months)	X	U	U
0+ = Up to 13 kg (28 lb) (birth to 18 months)	X	U	U
I = 9 to 18 kg (20 - 40 lb) (9 months to 5 years)	UF	U & L	U
II = 15 to 25 kg (33 - 55 lb) (4 to 7 years)	U	U	U
III = 22 to 36 kg (48 - 80 lb) (6 to 12 years)	U	U	U
<p>Key: U: Suitable for Universal category restraints approved for use in this mass group. UF: Suitable for forward facing Universal category restraints approved for use in this mass group. L: Suitable for particular vehicle specific child restraint given below. These restraints may be of the specific-vehicle, restricted or semi-universal categories. X: Seat position not suitable for child restraint in this mass group. The safest place to transport children is the rear seat.</p> <p>* Jaguar recommend that the front passenger seat be positioned fully rearward with the cushion adjusted to its highest position when installing child restraints.</p>			
<p>Type L Child Restraint = Jaguar branded Romer Duo ISOFIX Group 1 restraint - see Jaguar Dealer/Authorised Repairer.</p>			

Caution: Information given within the table is correct at the time of going to press. However, availability of child restraints may change. Please consult your Jaguar Dealer/Authorised Repairer for the latest recommendation.

Note: The legislation which governs how and where children should be carried when travelling in a vehicle, is subject to change. It is the responsibility of the driver to comply with all regulations in force.

Child Safety

SECURING CHILD RESTRAINTS

Some countries have passenger seat belts (not the driver's) with an automatic locking device for use with child seats, your Jaguar Dealer/Authorised Repairer can give you details.

If engaged, this device allows the belt to be retracted (tightened) but not pulled out. When used to secure a child seat, therefore, the belt will automatically lock at any point to which it has retracted.

Always ensure that child restraint assemblies are fitted in strict accordance with the child restraint manufacturer's instructions. Keep the fitting instructions for future reference.

The following checks should always be carried out:

- Fit the child seat in the correct position and secure with the seat belt in accordance with the manufacturer's instructions. If necessary, remove the head restraint to accommodate a larger child seat.
- Make sure the child seat is fitted firmly to the car seat. There should not be excessive forward or sideways movement.
- Pull the seat belt all the way out to engage the locking device. To fix the seat firmly, retract the belt back onto the reel; a ratchet operation may be felt as the belt retracts. Continue to pay the belt back onto the reel until it fits snugly around the child seat.
- Regularly check and refit the child seat to ensure there is no slack in the installation.

- The seat belt must not be twisted and the buckle must not rest on the child seat frame, as it may snap open in an accident.
- Never modify the seat, or install it differently to the instructions.

The above is a guide only. Depending on the features of a particular child seat, e.g. forward or rearward facing, engage the locking device before or after attaching the belt, as convenient.

Unbuckling the belt and releasing the child seat will allow the belt to resume its normal operation.

Always secure an unoccupied child seat safely. In an accident an unsecured child seat may pose a risk to the vehicle occupants.

If a booster seat is used, position the lap section of the adult seat belt over the child's pelvis. The diagonal seat belt should rest on the child's shoulder, not the neck.

Child Safety

SAFE USE OF CHILD RESTRAINTS



WARNING:

The top tether anchor point must always be used to secure forward-facing child seats. See “Tether strap anchorages (Australia only)” on page 73.

Ensure that there is no slack in the webbing and that the restraints fit the child snugly across the rib cage and hips. These are the parts of the body most able to take the force of an impact.

- Ensure the path and position of an integral harness across the shoulders is appropriate for your child’s development – consult the manufacturer’s instructions.
- The lap strap should pass across the top of the child’s thighs, bearing on the pelvis, not the abdominal area.
- Adjust the harness every time, so that one or two fingers only can be inserted between the child and harness. Different clothing on a child can make a difference to the correct fitting of the harness.
- Make sure the harness webbing is not twisted.
- Never modify the seat harness or buckles, as this may affect the quick release mechanism.
- Always secure your child correctly, even for the shortest journey.
- Follow the seat manufacturer’s instructions for harness adjustments.

Check List - Non-ISOFIX Child Restraints

Follow the check list each time your child travels in the vehicle:

- Carefully follow the instructions provided by the manufacturer of the restraint system.
- Always use the appropriate child restraints and adjust harnesses for every child, every trip.
- Avoid dressing your child in bulky clothing and do not place any objects between the child and the restraint system.
- Regularly check the fit of your child seat and replace seats or harnesses that show signs of wear.
- Ensure that you have removed all slack from the adult seat belt.
- No child seat is completely child-proof. Encourage your child not to play with the buckle or harness.
- Never leave a child unsupervised in the vehicle.
- Activate the rear door child safety locks.
- Ensure your child does not exit the vehicle from the side where there is traffic.

Set your child a good example – always wear your seat belt.

Child Safety

ISOFIX CHILD RESTRAINTS



WARNING:

To ensure the Jaguar ISOFIX child seat is installed safely, read all the information provided.

(Saloon models only)

Only the Britax Roemer Duo Plus ISOFIX restraint is approved by Jaguar for use with this system. An ISOFIX anchorage kit must be fitted to your vehicle before the ISOFIX seat can be installed. These brackets must be supplied and fitted by your Jaguar Dealer/Authorised Repairer. The ISOFIX anchorage kit and the ISOFIX seat cannot be installed in Estate models.

The ISOFIX system allows an ISOFIX child seat to be secured directly and easily to the vehicle body without the use of adult seat belts.

Many injuries to children in accidents are caused by the incorrect fitting and tensioning of the adult seat belts, which are normally used to secure child seats. The ISOFIX system reduces the likelihood of incorrect fitting and is also quicker and simpler to use.

The ISOFIX system uses two anchorage loops and a top tether bracket fixed to the vehicle body. The ISOFIX child seat has two retractable lower catches that lock onto the anchorage loops and a strap that clips onto the top tether bracket. The child seat has a quick release mechanism to allow it to be removed easily.



This symbol on the seats indicates the location of the ISOFIX lower anchorages.

The anchorage loops are accessible through the gap between the rear seat back and cushion, located approximately 60 mm (2.5 inches) below each label for both outer seat positions. Removable plastic guides are supplied with the ISOFIX seat to allow the seat to be fitted easily.

Estate models only

ISOFIX seat fixings are NOT provided on Estate models.

Child Safety

CHILD SEAT ANCHOR POINTS

Isofix anchor points



WARNING:

Do not attempt to fit an ISOFIX child seat to the centre seating position - the anchor bars are not designed to hold an ISOFIX child seat in this position. If the child seat is not correctly anchored, there is a significant risk of injury to the child in the event of a collision or emergency braking.



WARNING:

If provided, the top tether must always be used to secure forward-facing child seats.



WARNING:

If removing a head restraint in order to fit a child restraint, always secure the head restraint when storing it. If left loose in the vehicle it may cause death or serious injury during sudden braking or an impact.



WARNING:

Always follow the child seat or restraint system manufacturer's instructions when fitting tether straps.

Both rear outer seating positions, are equipped to accept ISOFIX restraints.

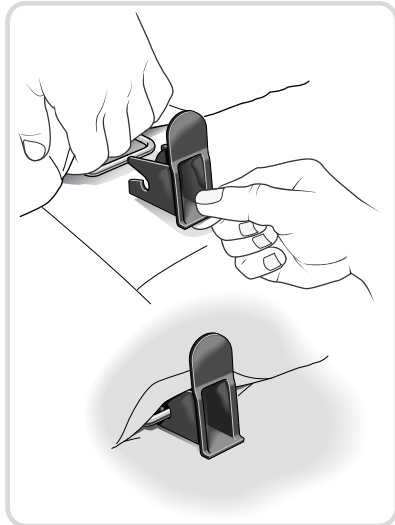

JAG0681

Plastic guides are supplied to make it easier to fit the child seat and avoid damage to the vehicle's seat covers. If correctly fitted, the guides will normally remain in place when the child seat is removed.

Child Safety

Open up the gap between the seat cushion and seat back to expose an anchorage loop. Locate the cut-outs at the rear of the guide onto the anchorage loop and push the guide fully in until it clips in place on the anchorage loop. Fit the second guide.

Note: *The plastic guides must be removed before folding down the seat backs. Pull out the guides to remove.*

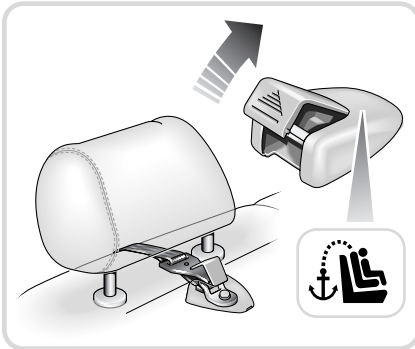
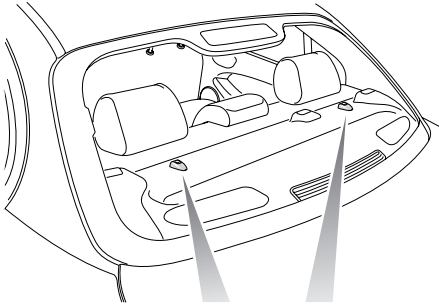

JAG0683

Upper tether anchorages are provided at each seating position equipped to accept ISOFIX child restraints (shown in the illustrations). The brackets are positioned on the rear parcel shelf, under access covers, at the centre-line of the outboard rear seating positions.

Pass the top tether strap under the vehicle rear head restraint to connect to the top tether bracket on the parcel shelf. Adjust the length of the top tether strap to hold the top of the child seat against the vehicle seat back.

Fit the child seat and follow the ISOFIX check list.

Tether strap anchorages (Australia only)

 **WARNING:**

Child restraint anchorages are designed to withstand only those load imposed by correctly fitting child restraints. Under no circumstances are they to be used for adult seat belts, harnesses or for attaching other items or equipment to the vehicle.

 **WARNING:**

When fitting a child seat or restraint system, always pass the tether strap over the top of the seat back and beneath the underside of the head restraint.

There are three tether strap upper anchorage points positioned on the rear parcel shelf, under access covers. These should be used to attach tether straps from child seats or restraint systems.

Child Safety

FITTING THE ISOFIX SEAT



WARNING:

Always follow the manufacturer's instructions supplied with the ISOFIX child seat. The following is to be considered only as a guide.

Always ensure the child seat attachment legs and the vehicle anchorage loops are kept clean and free of dirt.

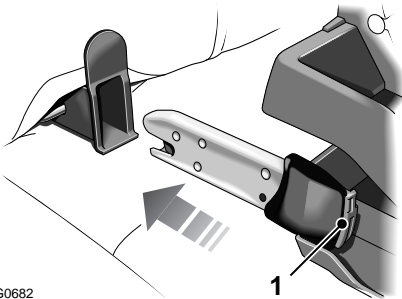

JAG0682

1. ISOFIX seats can only be installed in the rear outboard seating positions.
2. Make sure the adult seat belts and buckles do not become trapped behind the child seat.
3. Make sure there is nothing obstructing the seat mounting mechanism at the anchorage points.
4. Release the green lever on the rear of the seat and fully extend the two attachment legs on the child seat. Ensure the hook at the end of each leg is open.

5. Position the attachment legs just in front of the plastic guides (see illustration on this page). Press in the green locking button (1) on one of the anchorage legs and push the anchorage leg through the plastic guide to engage with the vehicle's anchorage loop. There should be an audible click.
6. Repeat Step 5 for the seat's second anchorage leg.
7. Using firm and even pressure on both sides, push the child seat rearwards until it is secured firmly against the vehicle seat back. Make sure you do NOT trap the top tether strap behind the child seat.
8. Attach the top tether. See "" on page 73.
9. As a final check, firmly pull both sides of the seat to confirm that it is correctly locked in position.

Seat with tether straps - Clip the flexible lower straps to the two anchorage points. Adjust the length of each strap until the seat is held firmly against the vehicle seat back.



WARNING:

Do not install a child seat with flexible lower attachments in the vehicle centre seat position. The anchorage loops are only provided to install a compatible child seat in the vehicle outboard seat positions.



WARNING:

The top tether must always be used to secure the ISOFIX child seat.

Child Safety

ISOFIX CHECK LIST



JAG0711

Follow the check list each time your child travels in the vehicle:

- **Always attach the top tether when installing the ISOFIX seat.**
- Carefully follow the instructions supplied with the child seat.
- Always give the ISOFIX seat a final pull to ensure the lower anchors are secure, even if the green buttons indicate that the seat connectors are latched.
- Always use the appropriate child restraints and adjust harnesses for every child, every trip.
- Make sure your child falls into the correct weight range for the seat (9 - 18 kg [20 - 40 lb]).
- Avoid dressing your child in bulky clothing and do not place any objects between the child and the restraint system.

- Regularly check the fit of your child seat and replace seats or harnesses that show signs of wear.
- No child seat is completely child-proof. Encourage your child not to play with the buckle or harness.
- Never leave a child unsupervised in the vehicle.
- Activate the rear door child safety locks. See “CHILD SAFETY LOCKS” on page 50.
- Ensure your child does not exit the vehicle from the side where there is traffic.
- Set your child a good example - always wear your seat belt.

REMOVING ISOFIX SEATS

Removing an ISOFIX seat

To remove the ISOFIX child seat, undo the top tether strap. Press the green locking button on each side of the seat to release the anchorage legs and lift the child seat from the vehicle.

Seats

SITTING IN THE CORRECT POSITION

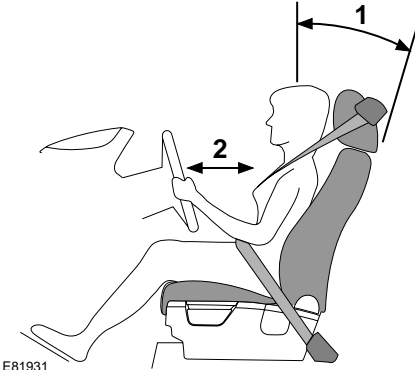

WARNING:

Do not adjust the seat while the vehicle is moving. Doing so could cause loss of vehicle control and personal injury.

The seat, head restraint, seat belt and airbags, all contribute to the protection of the user. Correct use of these components will give you greater protection, therefore you should observe the following points:

1. Sit in an upright position with the base of your spine as far back as possible and the seatback reclined no more than 30 degrees.
 2. Do not move the driver's seat too close to the steering wheel. Ideally, a minimum distance of 254 mm (10 inches) is recommended between the breastbone and the steering wheel airbag cover. Hold the steering wheel in the correct position with your arms slightly bent.
- Adjust the head restraint so that its highest point is level with the top of your head.
 - Position the seatbelt so that it is mid-way between your neck and your shoulder. Fit the strap tightly across your hips, not across your stomach.
 - Ensure that your driving position is comfortable, and enables you to maintain full control of the vehicle.

Seats

HEAD RESTRAINTS

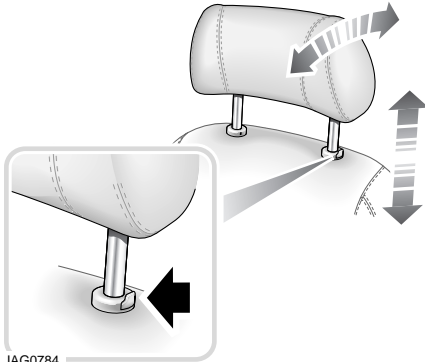

JAG0784

Each front head restraint can be adjusted to give the correct height for the seat occupant. They may also be manually tilted.

To lower: Press the lever in the escutcheon and push the head restraint into the seat back to the required height.

To raise: Pull the head restraint upwards.

Rear centre head restraint

The rear centre head restraint has two positions only. It can be stowed within the seat back when not in use and should be extended when an occupant is in the centre seat.



WARNING:

Head restraints are designed to support the head, not the back of the neck. The restraint must be positioned correctly to restrain rearward movement of the head in a collision. An incorrectly adjusted head restraint increases the risk of death or serious injury in the event of a collision.



WARNING:

For optimum protection, the driver and passenger should sit in the centre of the seat with the head as close as possible to the head restraint.



WARNING:

Adjust the head restraint so that it is just behind your head and never behind your neck.



WARNING:

Do not make adjustments when the vehicle is moving. Doing so could cause loss of vehicle control and personal injury.



WARNING:

Adjust the head restraint so that the top of the head restraint is above the centre line of the head. An incorrectly adjusted head restraint increases the risk of death or serious injury in the event of a collision.



WARNING:

Do not drive, or carry passengers with the head restraints removed from occupied seats. The absence of a correctly adjusted head restraint increases the risk of death or serious injury in the event of a collision.

Seats

FRONT SEAT CONTROLS



WARNING:

Do not adjust the seat while the vehicle is moving. Doing so could cause the loss of vehicle control and personal injury.

A key does not have to be in the starter switch for seat adjustment.

There are three different methods of controlling the seat adjustment. 4-way adjustment allows the occupant to adjust the seat height and the angle of the seat back electrically. 6-way adjustment gives the same functions and adds electrical adjustment of the lumbar support. To adjust the position of the seat forwards and backwards, lift the lever under the front of the seat.

10-way adjustment is only available with driver memory seats, and adds electrical adjustment of the seat base angle as well as forward and backward movement.

Note: All control switches are located on the side of the seat valance.

Driver and front passenger seats have the same controls, except with 10-way adjustment seats, where only the driver's seat is fitted with a memory function.

4-way electrical seat adjustment

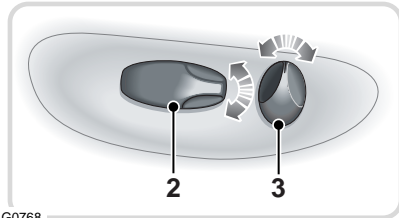
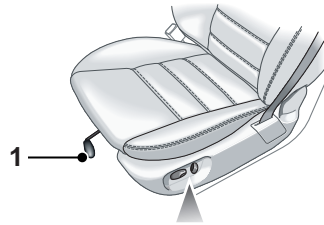

JAG0768

1. Controls the seat position. To move the seat forward or rearward - lift the lever and slide the seat. Release the lever and ensure the seat is locked in position before driving.
2. Controls the seat height. Pull the switch up or down to raise or lower the seat.
3. Controls the seat back angle. Move the switch rearwards to recline or forwards to raise the seat back angle.

Seats

6-way electrical seat adjustment

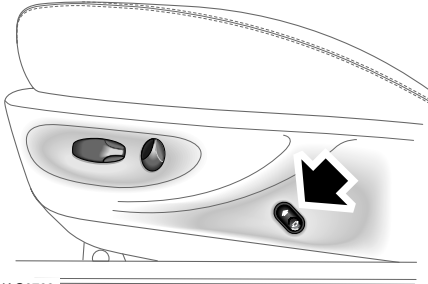

JAG0769

6-way seat adjustment controls are the same as the 4-way, but the occupant benefits from a further, lumbar support switch (arrowed). To increase lumbar support press the top of the switch, to decrease press the bottom.

10-way electrical seat adjustment - memory seats

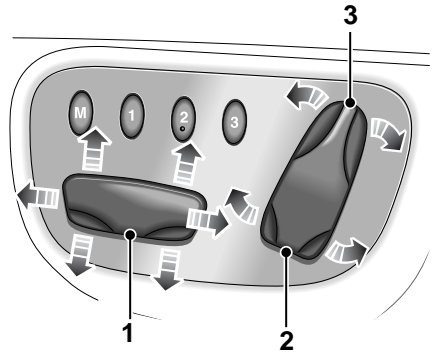

JAG0770

1. Controls the seat position. To move the seat forward or rearward - move the switch forwards or rearwards. Front/rear of cushion raise/lower - move the front or rear of the switch up or down. If both front and rear are raised or lowered together, the whole seat cushion will raise or lower.
2. Seat back angle switch.
3. Lumbar support switch.

Passenger seat

The 10-way adjustable passenger seat is not fitted with memory buttons.

Seats

DRIVER'S SEAT ADJUSTMENT (WITH MEMORY)

This facility allows the positions of the driver's seat and door rear-view mirrors to be memorised and recalled for different occupants.

Up to three settings can be stored. The switch pack is located towards the front of the driver's seat base, next to the driver's door (as shown in the illustration on the previous page).

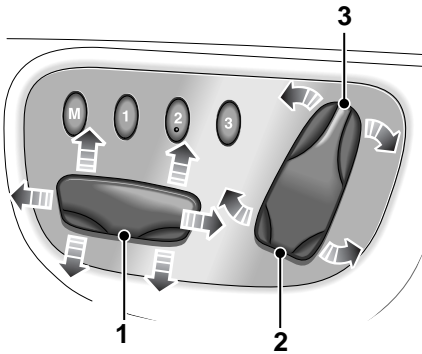

JAG0770

Setting a memorised position

1. Controls the seat position. To move the seat forward or rearward - move the switch forwards or rearwards. Front/rear of cushion raise/lower - move the front or rear of the switch up or down. If both front and rear are raised or lowered together, the whole seat cushion will rise or fall.
2. Controls the seat back angle. Tilt the top of the switch rearwards or forwards to recline or raise the seat back angle.

3. Controls the lumbar support (where fitted). Push the bottom of the switch rearwards or forwards to increase or decrease lumbar support.

To store a driving position in the memory:

1. Adjust the seat and door mirrors to the desired positions.
2. Push the memory button **M** (see previous illustration). A chime will sound.
3. Within five seconds of pushing the **M** button, push button **1**, **2** or **3** to memorise the configuration. A double chime will sound, and, if the starter switch is ON, a message will be displayed in the message centre to indicate that the procedure was successful.

By repeating these three steps and pressing the unused buttons, two more driving positions can be stored in the memory.

To set a new driving position, adjust the driver's seat and door mirrors and perform steps 2 and 3. The previous memory will be erased and the new position will be stored.

Note: Button **M** is concave, and there is a raised point on button **2**. This allows the buttons to be identified by touch.

Seats

Recalling a memorised position

Ensure the gear selector lever is in position **P** and the handbrake is on.

Press and release the appropriate memory button (**1**, **2** or **3**). The seat and door mirrors will move automatically to the memorised position.

If the door mirror or seat position switches are operated whilst the seat and door mirrors are repositioning, the process will be cancelled. Press the memory button again to resume.

Note: *The memory function will only operate if:*

- *The handbrake is on (manual transmission only).*
- *Automatic transmission is set to **P**.*

FRONT SEAT HEATERS (Where fitted)



JAG0714

Each front seat back and cushion has a heater controlled by a switch on the centre console.

With the starter switch in position **II**, press the switch to turn the heaters on.

The first press will heat the seat to a high temperature setting, a second press will heat the seat to a lower setting.

A third press will turn the seat heater off.

The switch illuminates when the heater is on, red for the high heat setting and yellow for the lower setting.

The heater will automatically switch off:

- After it has been on for 10 minutes.
- If the starter switch is turned off.
- If a fault is detected.

The heater will maintain a preset temperature while it is switched on.

Storage of the vehicle in a heated garage, body heat or warm ambient temperatures may prevent operation of the seat heater.

Clock

CLOCK ADJUSTMENT

The position of the digital clock depends on the equipment fitted to the vehicle.

If a touch-screen is fitted to the vehicle, the clock will be incorporated in the touch-screen display.

If the vehicle is not equipped with a touch-screen, the clock is included in the audio display.

Note:

- For more information concerning the operation of the audio system controls, refer to the audio systems handbook.
- For more information concerning the operation of the touch-screen, refer to the Jaguar Touch-screen Handbook.

Non-touch-screen



JOL4693

1. Repeatedly press and release the **MODE** button (on the audio unit) until **ADV MODE N/Y** is displayed.
2. Rotate the volume control to select **ADV MODE YES** and then press **MODE**.
3. **CLOCK SET** will be displayed with the 12/24 hours indicator flashing. Rotate the volume control clockwise for 24-hour display; counterclockwise for 12-hour display.
4. Press **MODE** to select the hour setting. Rotate the volume control clockwise or counterclockwise to adjust the setting.
5. Press **MODE** to select the minutes setting. Rotate the volume control clockwise or counterclockwise to adjust the setting.
6. To exit press and hold **MODE** or wait approximately five seconds until the display reverts to audio mode.

Clock

Vehicles with touch-screen



JAG0804

If the vehicle is fitted with a touch-screen, the clock is adjusted as follows:

1. Press the **MENU** button on the touch-screen control panel. The system menu screen will be displayed.
2. Touch the **System Setup** button on the **MENU** screen.
3. Touch the **Set Clock** button on the **SYSTEM SETUP** screen.
4. Clock adjustment is made by touching the hour or minute, up or down arrow buttons.
5. Touch the **12/24** button to select twelve or twenty-four hour display.
6. Confirm your setting by touching **Set**.

Steering Column

COLUMN RELEASE LEVER

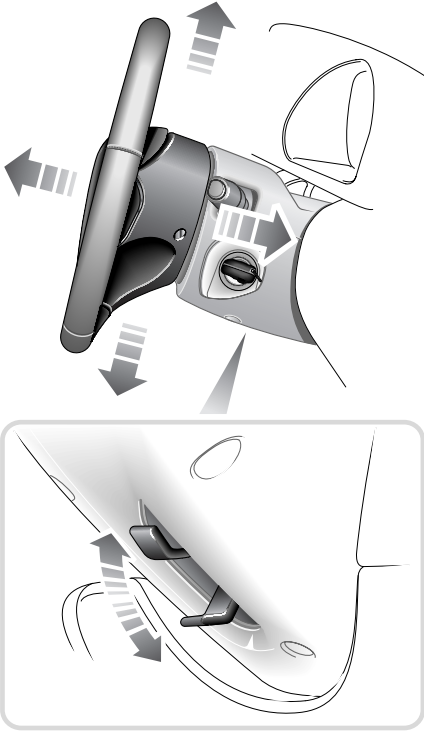

JAG0712



WARNING:

Never adjust the steering wheel position whilst the vehicle is in motion. Doing so will reduce control of the vehicle, and may cause unpredictable steering movements.

The steering column can be adjusted for reach and height.

Holding the steering wheel, push the release lever fully downwards.

Move the steering wheel up or down and in or out as required, for a comfortable, safe driving position.

After adjustment, fully raise the lever to lock the steering wheel in position.

Door Windows

WINDOW SWITCHES

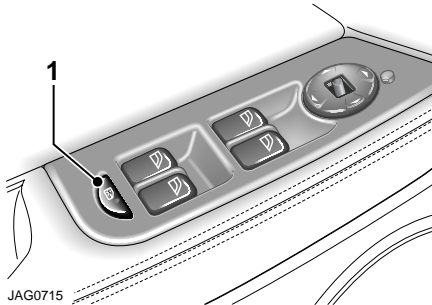

JAG0715

Front windows on all models are electrically operated. Depending on the model, rear windows can be either manually or electrically operated.

ELECTRIC WINDOW OPERATION

Switches on the driver's door switch pack control the driver and passenger door windows.

The passengers are provided with a switch to control their door window only.

These switches will only operate the window when the starter switch is in position **II**.

If rear electrically operated windows are fitted, button **(1)** immobilises the rear window switches preventing passengers from operating their windows. The button illuminates red when the rear windows cannot be operated by the rear seat passengers.

Note: *If a resonance (booming sound) occurs with the rear windows open, lower the front windows about 0.5 inches (15 mm). This will eliminate the noise, by altering the frequency of the air moving in and out of the vehicle.*



WARNING:

If children are carried in the rear seats, the isolator switch should be used to prevent operation of the windows. If the windows are operated by young children there is a risk of serious injury or death.



WARNING:

All of the windows have an anti-trap protection system. However, before closing a window care must be taken to ensure that none of the occupants have any part of their body in a position where it could be trapped. Even with an anti-trap system serious injury or death can occur.



WARNING:

Ensure that you remove the keys when leaving occupants in the vehicle. This will prevent unsupervised operation of the windows, which may result in injury.

Operation

To lower a window, press down the switch to its first position and hold until the desired position is reached, then release.

To close a window, pull the switch upwards to its first position and hold until the desired position is reached, then release.

Door Windows

If the switches are held for longer than six seconds, for example, when attempting to overcome frozen or jammed windows, the window drive will be switched off for a few seconds to protect the window drive motors.

One-touch operation

Each window has a one-touch facility enabling the occupant to fully open or close the window in one quick movement. Pulling, or pressing, the switch to its second position and quickly releasing will close or open the window in one movement. Window travel can be stopped at any time by pressing the switch again.

Wind resonance with lowered windows

Due to the sleek exterior of the vehicle, it is possible for a resonance, booming sound, to occur when one or both rear windows are open; this is eliminated by slightly opening an adjacent front window.

Door Windows

WINDOW ANTI-TRAP FEATURE

Window anti-trap protection

Each electrically operated window has an anti-trap protection feature. If the upward movement of the window detects an obstacle, the anti-trap system will immediately stop the window closing, then move it downwards for a short distance.

Note: *If the battery is disconnected or discharged, the window anti-trap feature is lost. When the battery is reconnected or recharged the window anti-trap system must be reset.*

Resetting the electrically operated windows anti-trap feature

- Fully close the window, hold the switch in the close position for two seconds and then release the switch. Wait for two seconds, do not open the window.
- Again, select the same window to close, holding the switch for a further two seconds.
- Check to confirm the operation by opening the window and then use one-touch operation to close the window.
- Repeat for the remaining electrically operated windows.

Overriding the anti-trap protection

The anti-trap system will also stop the window closing if a blockage or resistance occurs e.g. in the window guide channels. Typically this might be due to icing in winter but could also be caused by damage or misalignment of the guide channels or seals.

To override the anti-trap action:

- After the initial attempt to close the window, operate the close switch a second time.
- When the window has reversed from the blockage, operate the switch (within 10 seconds) until the window stops again (it will not reverse on the third attempt).
- Immediately operate the close switch again. The window will now move up a short distance with increased force to override the blockage.
- Repeat the override action until the window has closed. Each time the window stops, the switch must be operated immediately to initiate further override action.

If this procedure fails to move the blockage, the anti-trap feature will be lost and must be reset (see first column) after the blockage has been cleared.

Thermal overload

If the windows are repeatedly opened and closed (e.g. by a child), a protection system will deactivate window operation for a short period to avoid overheating of the window motors.

Mirrors

DOOR REAR-VIEW MIRRORS

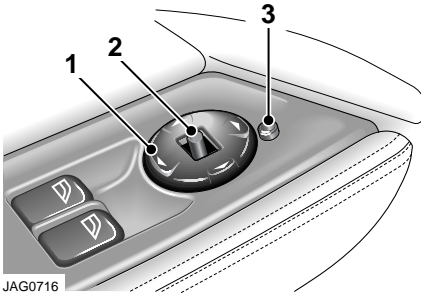

Both door mirrors are adjusted from the driver's door switchpack. The four-way adjustment button (1) moves the mirrors to the required position. The selector switch (2) selects the mirror to be moved, left for the left-hand side mirror and right for the right-hand side mirror. When the selector switch is in the centre position, adjustment to either mirror is inhibited.

Each mirror housing, except the power fold back door mirror, is designed to pivot against the vehicle upon impact. To return the mirror to its normal position, reposition the housing until it locks into place.

Mirror heating

The door mirrors have heating elements which work when the rear screen heater is switched on. The mirror heater will clear all ice from the mirror surface.

Caution: Do not use a scraper to remove ice from the mirrors as this will damage the surface.

Power fold back (Where fitted)

To assist parking by reducing the overall vehicle width, the door mirrors can be folded inwards.

The button (3) is located in the driver's door window switchpack and will operate the mirrors when the starter switch is in any position except off.

To fold the mirrors inwards press the button. A second press of the button returns the mirrors to their normal driving position.

Note:

- *If the button is pressed repeatedly, a thermal cut-out will prevent damage to the vehicle's electronics. If this occurs, wait for five minutes for the cut-out to reset, before operating the button.*
- *If the thermal cut-out operates and leaves the mirrors in the folded position, the mirrors can be folded outwards manually.*
- *If the door mirrors are repositioned manually (or are knocked out of position), the mirror head will be loose. To re-engage the mechanism, power the mirror to the foldback position, then outwards to the drive position.*



WARNING:

Do not drive the vehicle with the door mirrors in the folded position, except when parking.

Mirrors

INTERIOR REAR-VIEW MIRROR

Auto-dimming mirror

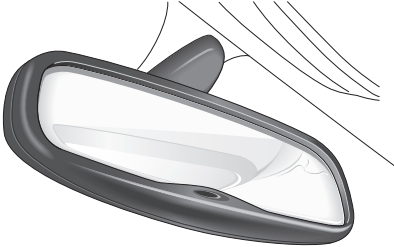

JAG0718

The auto-dimming rear-view mirror darkens automatically to prevent glare from a following vehicle's headlamps. The mirror clears when light levels return to normal. The mirror also clears when reverse gear is selected.

Note:

- *Should a mirror assembly become detached from the windscreen, it must be refitted by a Jaguar Dealer/Authorised Repairer.*
- *Ensure that the windscreen in front of the mirror is kept clean. The moisture sensor for wiper operation is located on the front of the mirror casing, so any dirt may affect the operation of this sensor.*
- *The automatic darkening of the mirror will not operate properly if the light that would otherwise strike the mirror is obstructed.*

Luggage Compartment

LOADING THE VEHICLE



WARNING:

Locate heavy loads in the luggage compartment towards the front of the vehicle and secure them to stop them sliding. Loose items can be a hazard.



WARNING:

Do not drive with the luggage compartment lid open as exhaust fumes can be drawn into the passenger compartment.

Four metal loops are positioned in the luggage compartment for attaching straps to secure loads and prevent them from sliding over the luggage floor.

These loops are not to be used for securing passengers or animals nor as anchorages for child restraints.

LUGGAGE TIE-DOWN LOOPS - SALOON

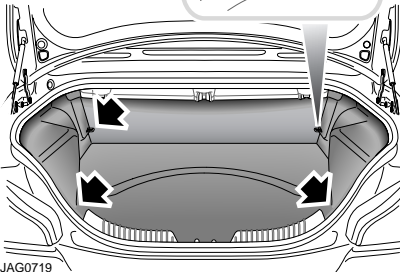
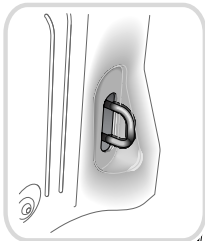

JAG0719

LUGGAGE TIE-DOWN LOOPS - ESTATE

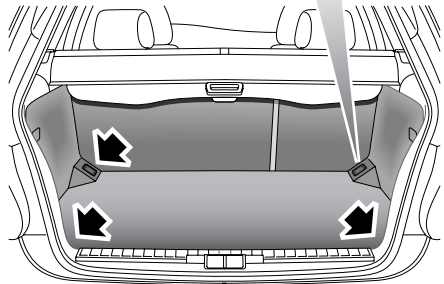
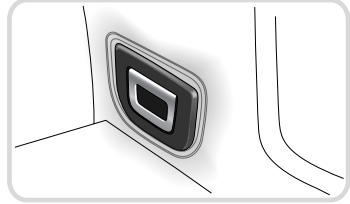

JAG0720

A range of Jaguar storage accessories, including a luggage retaining net, is available from your Dealer.

It is advisable to distribute luggage weight evenly over the entire luggage floor area, particularly to prevent permanent damage to the seat trim when a seat has been folded down.

Luggage Compartment

REAR SEAT BACK FOLD DOWN

To provide a longer luggage compartment area, the backs of the rear seat can be folded down in two parts to give a 70/30 width split.

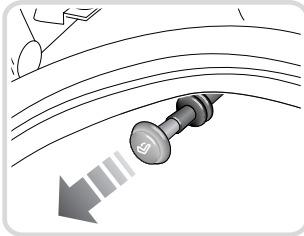
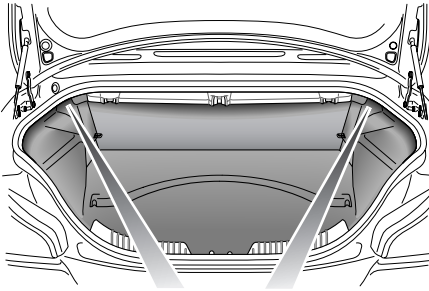

JAG0721

Saloon: Release handles for each seat back are in the luggage compartment under the parcel shelf. Pull the handle to release the seat back.

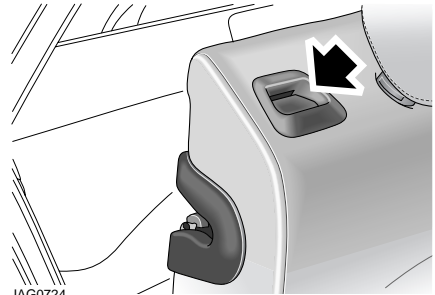

JAG0724

Estate: Release catches are located on the top of each seat back. Press the catch to release the seat back.

Once the seat back is released, fold it onto the seat cushion.

When folding the seat back, ensure that the armrest is stowed and that there is sufficient clearance between the seat back (including the head restraint) and the back of the front seat.

When returning the seat back to the upright position, ensure that the seat belts are routed correctly and are not trapped by the seat back. Press the seat back firmly and check that it is locked securely into place.

Note: There is a red indicator to the rear of each release catch, which is only visible when the seat is unlatched.

When returning the seat back to the upright position, ensure the catches lock correctly: when locked, the red indicator on each catch is obscured.

Caution: There is an interlock between the centre seat belt and the seat latch: if the catches are not locked correctly, the centre seat belt will not operate.

Luggage Compartment

ESTATE LUGGAGE COVER

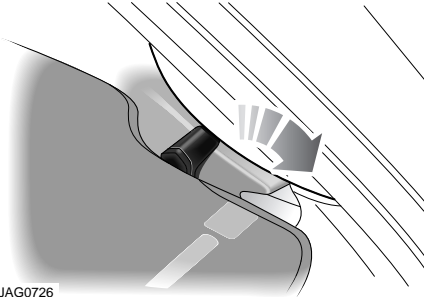

JAG0726

The luggage cover can be extended to hide the contents of the luggage compartment. The cover retracts into the housing when not required.

To extend the luggage cover, pull the handle towards you. There is a lug on either side of the luggage cover: slide the lugs into the catches on either side of the rear of the luggage compartment.

To retract the luggage cover, grab the handle and lift the lugs out of the catches. Gently allow the cover to retract into the housing.

Removing the luggage cover

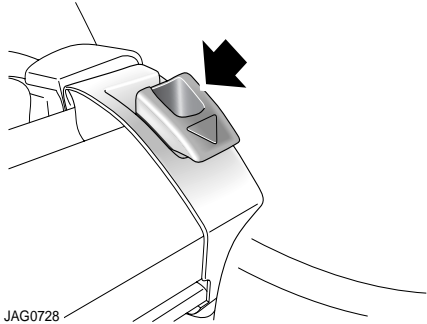

JAG0728

Caution: Care should be taken to avoid damaging the interior trim when removing the luggage cover.

- Retract the luggage cover (and luggage load net, where fitted) into the housing.
- Release the two catches on either end of the luggage cover housing (see above).
- Lift the housing slightly, until it is clear of the trim on either side of the luggage compartment.
- Rotate one end of the luggage cover towards you, and carefully guide the cover out of the car. Keep an eye on both ends of the cover and avoid contact between the luggage cover and the luggage compartment trim.

Alternatively, the luggage cover can also be removed through the rear passenger doors:

- Retract the luggage cover (and luggage load net, where fitted) into the housing.
- Fold down both sections of the rear seat (refer to the previous page).
- Release the two catches on either end of the luggage cover housing.

Luggage Compartment

- Lift the housing slightly, until it is clear of the trim on either side of the luggage compartment.
- Rotate one end of the luggage cover towards you, and carefully guide the cover out through the rear passenger door.

Refitting the luggage cover

To refit the luggage cover, manoeuvre it into place without resting it on the side trim of the luggage compartment. Make sure the luggage cover is locked securely in place, with both of the catches properly engaged.

Note: *There is a green indicator on each of the luggage cover catches, which indicate that the catches are securely locked. Ensure the indicator on each catch is visible once the luggage cover has been refitted.*

Luggage load net

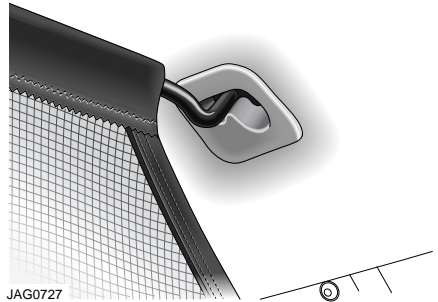

A luggage load net is fitted to some luggage cover housings. This can reduce the risk of luggage being thrown forward in the event of an accident, or under heavy braking. The load net can be retracted into the housing when not required.

When raising the net, it is easiest to reach it from the rear seat. Lift the net, and hook the catches on either end into the fittings in the roof. To retract the net, unhook the catches and lower the net into the housing.



WARNING:

A luggage net is not designed to restrain objects in the event of a collision.